

Article number: 439000050

Description: Rota-fix shaft-hub connection G50x80

Note: Self centering - very high torque

Measures

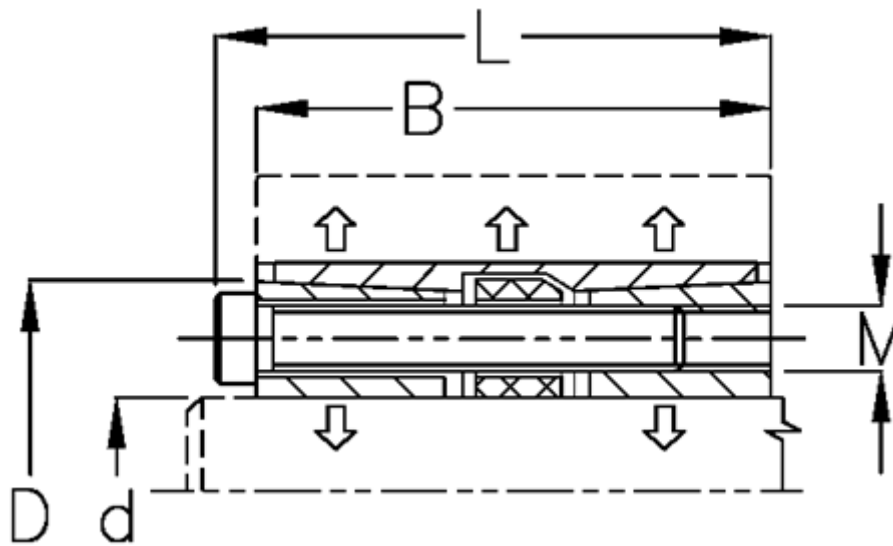

B mm	= 78
d H8 mm	= 50
D mm	= 80
Fit tolerance	= Aksel h8, Nav H8
F kN torque	= 180
L mm	= 86
M mm	= M8
P N/mm ² surface pressure on shaft/hub	= 65

Surface roughness	= R? ? 3.2 μm
T N m torque	= 3600
Ts N m bolt tightening torque	= 41